



Preco<sup>®</sup>

Concrete Accessories

A DCA Brand

# PRODUCT CATALOG

*Made in America*  *U.S. Veteran Owned*

---

Rebar/Mesh Supports • Spacer Wheels • Clips • Forming Accessories • Transportation Accessories • Tilt-Up Accessories

---

**DCA CONSTRUCTION PRODUCTS**

10421 Industrial Dr., Garrettsville, OH 44231 • 888-833-8308 • [www.dcaproducts.com](http://www.dcaproducts.com)



## TABLE OF CONTENTS

Shim Pack <b>(New)</b>	Page 2	HD Rebar Chairs <b>(New)</b>	Page 16	Keyway	Page 28
Shims	Page 3	Precast Rebar Chairs	Page 17	Wind Clip	Page 29
Transportation Accessories	Page 4 & 5	Barspan Clips	Page 18	De-Bonding Sheathing	Page 30
Hog Slat Chairs	Page 6 & 7	Rebar Clips	Page 19	Recess Plugs	Page 31
Bumper Curb Chairs	Page 8	Slab Bolsters	Page 20	Graphite Spray	Page 32
Wheel Assortment	Page 9 & 10	Board Cap	Page 21	Form Clean	Page 33
EAR Rebar Chairs	Page 11	T-Strip	Page 22	Set-Fast Silicone Sealant	Page 34
EAM Mesh Chairs	Page 12	Chamfers	Page 23 & 24	Neutral Cure Silicone	Page 35
High Stack Chairs	Page 13	Reveal Strip	Page 25	Sealant / Adhesive Guns	Page 36
Crown Chair <b>(New)</b>	Page 14	Rocket Dowels/Bases <b>(New)</b>	Page 26	Coil Loop Insert Protectors	Page 37
Paving Chairs <b>(New)</b>	Page 15	Slab Protector	Page 27	Panel Ties	Page 38
				Rebar Safety Cap	Page 39

Made in America  U.S. Veteran Owned

Rebar/Mesh Supports • Spacer Wheels • Clips • Forming Accessories • Transportation Accessories • Tilt-Up Accessories

DCA CONSTRUCTION PRODUCTS

10421 Industrial Dr., Garrettsville, OH 44231 • 888-833-8308 • [www.dcaproducts.com](http://www.dcaproducts.com)



## Preco<sup>®</sup> 4 x 6 Shim Pack – *NEW!*

### Application:

- Leveling of large precast panels, walls, and other structural concrete elevation adjustment needs
- Tilt-Up
- Cast-In-Place

### Features:

- Made in U.S.A.
- High load capacity – Compressive strength of 10,000psi
- Multiple sizes and thicknesses; pack includes:  
3 - 1/4" shims, 2 - 1/8" shims, 1 - 1/16" shim
- All 4" x 6" shims can be snapped in half to provide 2" x 6" shims.



ITEM #	PRODUCT CODE	PRODUCT DESCRIPTION	SIZES INCLUDED	PACKS/CTN.
331004750	SHIMPK	4" x 6" or 2" x 6" Shim Pack	1/4" (3pcs.), 1/8" (2pcs.), 1/16" (1pc.)	30

Made in America  U.S. Veteran Owned

Rebar/Mesh Supports • Spacer Wheels • Clips • Forming Accessories • Transportation Accessories • Tilt-Up Accessories

DCA CONSTRUCTION PRODUCTS

10421 Industrial Dr., Garrettsville, OH 44231 • 888-833-8308 • [www.dcaproducts.com](http://www.dcaproducts.com)



## Preco<sup>®</sup> Shims

### Application:

- Precast, Tilt-up, General Use
- Walls and Above Grade

### Features:

- High Load Capacity
- Multiple Sizes and Thicknesses for Various Needs

ITEM #	PRODUCT CODE	DESCRIPTION	SIZE	THICKNESS	QTY/CTN
331002731	SH202	White Shim	2" x 2"	1/2"	925
331002733	SH203	Green Shim	2" x 2"	3/8"	1,200
331002735	SH204	White Shim	2" x 2"	1/4"	1,600
331002737	SH208	Red Shim	2" x 2"	1/8"	2,600
331002739	SH216	Blue Shim	2" x 2"	1/16"	4,600
331003741	SH304	White Shim	3" x 3"	1/4"	685
331003743	SH308	Red Shim	3" x 3"	1/8"	1,400
331003744	SH316	Blue Shim	3" x 3"	1/16"	1,500
331003747	SHWG1	Shim Wedge	1-1/2" x 3-1/2"	1/16"-1/4"	2,000

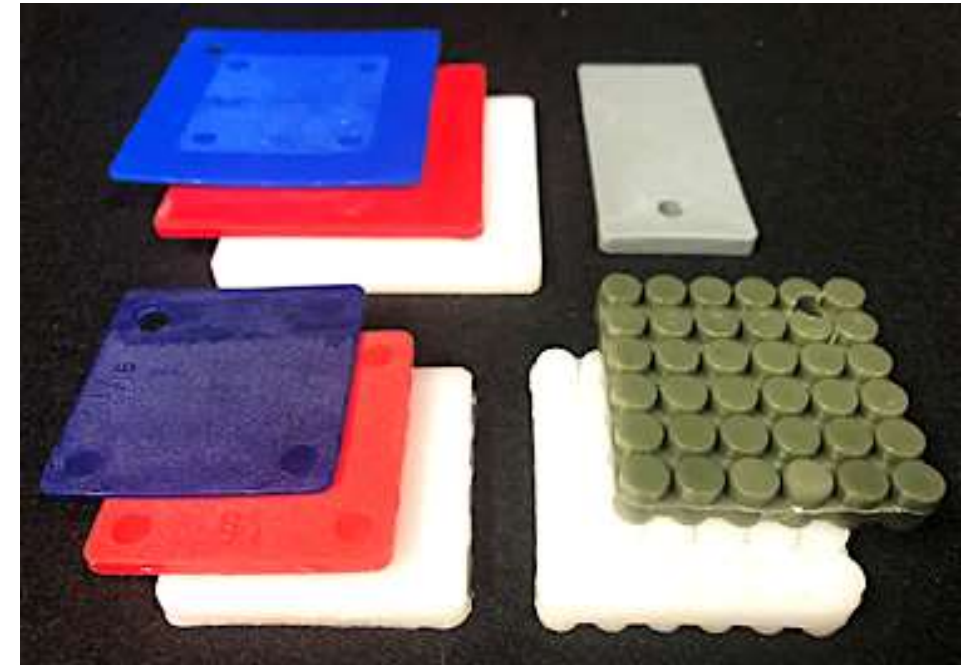

Made in America  U.S. Veteran Owned

Rebar/Mesh Supports • Spacer Wheels • Clips • Forming Accessories • Transportation Accessories • Tilt-Up Accessories

DCA CONSTRUCTION PRODUCTS

10421 Industrial Dr., Garrettsville, OH 44231 • 888-833-8308 • www.dcaproducts.com



## Preco<sup>®</sup> Transportation Accessories

### Application:

- Transportation guards are used to protect cargo from chains/straps during storage and transport.

### Features:

- Heavy duty design.
- Available in natural and safety orange
- Prevents strap from slipping
- Functional in low temperatures
- Used with chains, straps, ropes, banding, etc.

ITEM #	PRODUCT CODE	DESCRIPTION	SIZE	QTY/CTN
321501715	CG175	Chain Guard	1 3/4"	250
321504721	CG425	Chain Guard	4 1/4"	155
321504725	CG425-SO	Chain Guard - Safety Orange	4 1/4"	155
321504729	CG425-SO	Chain Guard - Safety Orange w/ Tear Web	4 1/4"	155



Made in America  U.S. Veteran Owned

Rebar/Mesh Supports • Spacer Wheels • Clips • Forming Accessories • Transportation Accessories • Tilt-Up Accessories

DCA CONSTRUCTION PRODUCTS

10421 Industrial Dr., Garrettsville, OH 44231 • 888-833-8308 • www.dcaproducts.com



## Preco<sup>®</sup> Transportation Accessories Cont'd

### Application:

- Used to protect and separate precast panels during curing, storage, and transport.
- Manufactured using natural, virgin material to avoid color contamination. (Will Not Stain Concrete)

### Features:

- Foldable for added thickness
- Economical design – more durable than wood
- Heavy Duty Panel Pad designed to hold extreme weight
- Can be nailed or screwed to wood

ITEM #	PRODUCT CODE	DESCRIPTION	QTY/CTN
311002701	ECOPD	6" x 2 1/2" x 3/8" Panel Pad	575
311502703	COPAD	2" x 3" Corner Panel Pad	400
311502708	PPNAI	6" x 2 1/2" x 1/2" Heavy Duty Panel Pad	400

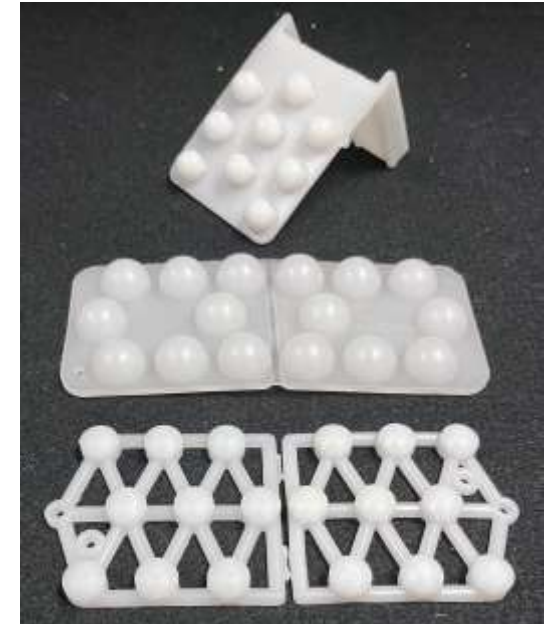

Made in America  U.S. Veteran Owned

Rebar/Mesh Supports • Spacer Wheels • Clips • Forming Accessories • Transportation Accessories • Tilt-Up Accessories

DCA CONSTRUCTION PRODUCTS

10421 Industrial Dr., Garrettsville, OH 44231 • 888-833-8308 • www.dcaproducts.com



# Preco<sup>®</sup> Hog Slat Chair

## Applications:

- Precast
- Quickly and accurately positions both bottom and top rebar in one fast and easy step

ITEM #	PRODUCT CODE	A	B	C	COVER	BAR SIZE	QTY/CTN
<b>Right Side Up Casting</b>							
181503511	SLATS	3"	4"	5"	3/4"	#3 - #4	800
181503513	SLATL	3"	5"	5"	3/4"	#3 - #4	700
181505519	SLATX	5"	5"	7"	3/4"	#3 - #4	500
181505517	SLAWS	5"	4"	5"	3/4"	#3 - #4	825
<b>Upside-Down Casting</b>							
181506521	SLATH	6"	4"	4"	3/4"	#4 - #5	700

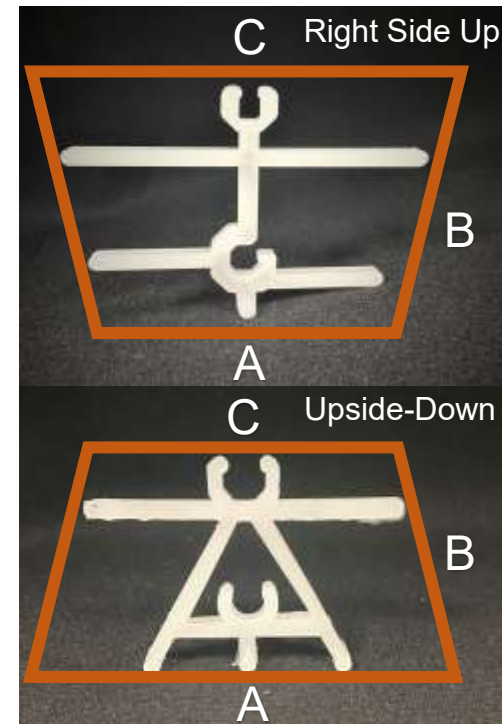

Made in America  U.S. Veteran Owned

Rebar/Mesh Supports • Spacer Wheels • Clips • Forming Accessories • Transportation Accessories • Tilt-Up Accessories

DCA CONSTRUCTION PRODUCTS

10421 Industrial Dr., Garrettsville, OH 44231 • 888-833-8308 • www.dcaproducts.com



## Preco<sup>®</sup> Hog Slat Chair Cont'd

ITEM #	PRODUCT CODE	DESCRIPTION	COVER	BAR SIZE	QTY/CTN	PICTURED
291001659	S1	1 1/4" Hog Slat Chair	5/16"	Mesh - 3/16"	7,700	1
291003661	S3x3/4	1 7/8" Hog Slat Chair	3/4"	#3	2,650	2
291004663	S4x3/4	2" Hog Slat Chair	3/4"	#4	2,300	3
291001667	S1x1	2 1/8" Hog Slat Chair	1"	Mesh - 3/16"	1,600	4
291003669	S3x1	2 1/4" Hog Slat Chair	1"	#3	1,400	5
291004671	S4x1	2 3/8" Hog Slat Chair	1"	#4	1,250	6
291005673	S5x1	2 5/8" Hog Slat Chair	1"	#5	800	7
291001768	S3x1-1/2	Hog Slat Chair	1 1/2"	#3	500	Not Pictured
291004672	S4x1-1/2	Hog Slat Chair	1-1/2"	#4	450	Not Pictured
161001502	S1/4 x 3/8 x 1	1 1/2" Top, 1" Bottom		#2 (top) #3 (bottom)	1,025	8
161001501	S1/4 x 1/4 x 1	1 1/2" Top, 1" Bottom		#2 (top) #2 (bottom)	1,100	9
291004656	S4x3x1	1 1/2" Top, 1" Bottom		#3 (top) #4 (bottom)	1,300	10
TBD	S3x3x1	1 1/2" Top, 1" Bottom		#3 (top) #3 (bottom)	TBD	11

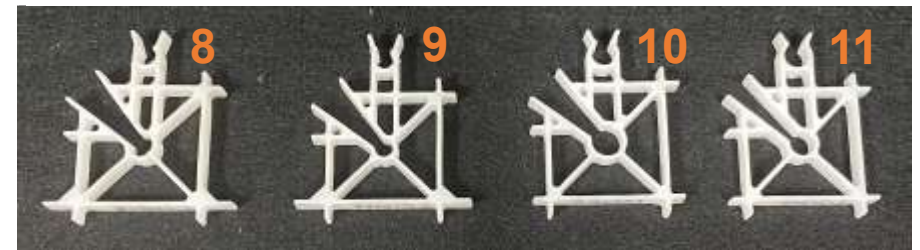
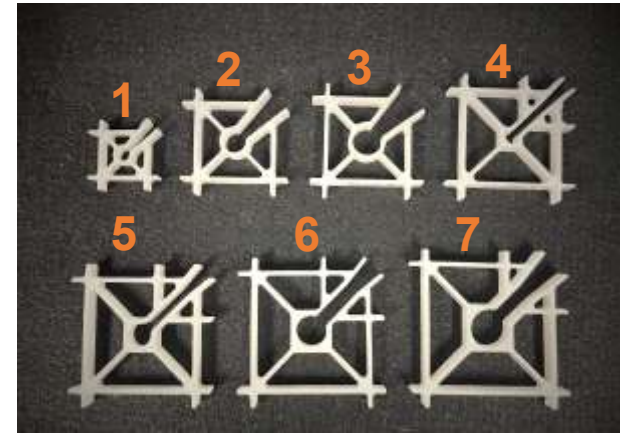

Made in America  U.S. Veteran Owned

Rebar/Mesh Supports • Spacer Wheels • Clips • Forming Accessories • Transportation Accessories • Tilt-Up Accessories

DCA CONSTRUCTION PRODUCTS

10421 Industrial Dr., Garrettsville, OH 44231 • 888-833-8308 • www.dcaproducts.com



## Preco<sup>®</sup> Bumper Curb Chair

ITEM #	PRODUCT CODE	DESCRIPTION	BAR SIZE	QTY/CTN	PICTURED
151005489	LIN-6	4-3/8" x 5-3/8", #3 Bar x 4	#3	235	1
151006491	LIN-8	7-3/4" x 6-1/2", #5-#6 Bar x 5	#5 - #6	135	2
151002493	LIN-10	7-1/2" x 8-1/4", Center & Upper Bars #5 x 3, Outer Bars #6 x 2	#5 & #6	105	3
151001495	LIN10-BOT	7 1/2" x 2 18"H, Center Bar #5, Outer Bars #6 x 2	#5 & #6	300	4
151002481	PB3	8-1/4" x 2-1/4", #3 Bar x 2	#3	350	7
151002483	PB4	8-1/4" x 2-1/4", #4 Bar x 2	#4	325	-
151002485	CTPB3	5-1/4" x 3 1/8", #3 Bar x 2	#3	400	-
151002487	CTPB4	5-1/4" x 3-1/8", #4 Bar x 2	#4	450	8
151001497	BCCHS	8-1/2" x 3-1/2", #3-#4 Bar x 2	#3 - #4	250	9
171002505	S3X2W	4 1/4" x 3" Wide Chair, #3 Bar	#3	525	5
171002507	S4X2W	4 1/4" x 3" Wide Chair, #4 Bar	#4	500	6
171002508	S5X2W	4 1/4" x 3" Wide Chair, #5 Bar	#5	350	-
211501549	SPMAR	1" Sign Post Marker	#3	430	-

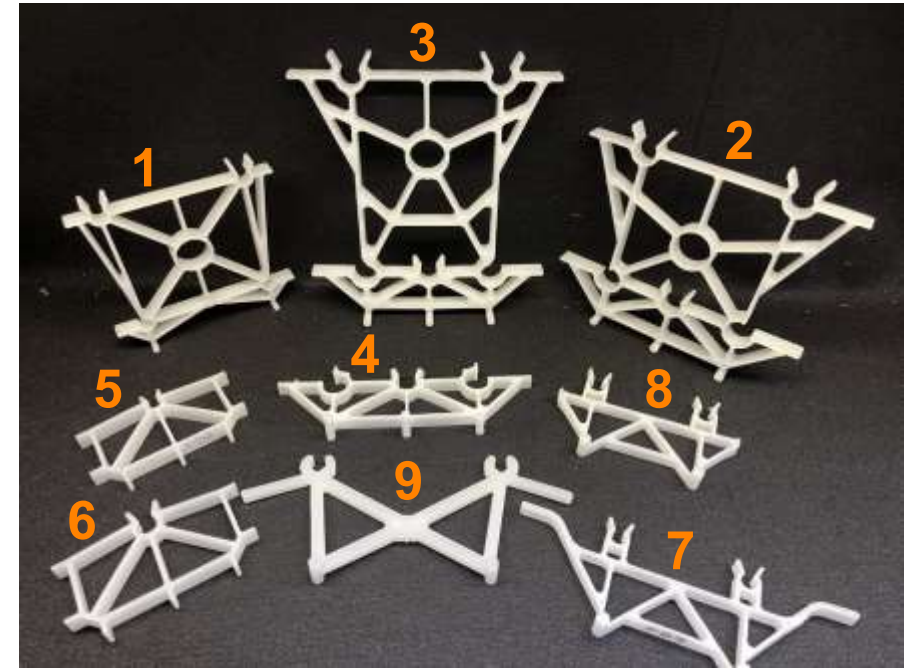

Made in America  U.S. Veteran Owned

Rebar/Mesh Supports • Spacer Wheels • Clips • Forming Accessories • Transportation Accessories • Tilt-Up Accessories

DCA CONSTRUCTION PRODUCTS

10421 Industrial Dr., Garrettsville, OH 44231 • 888-833-8308 • www.dcaproducts.com



## Preco<sup>®</sup> Wheel Assortment

ITEM #	PRODUCT CODE	COVER	BAR SIZE	QTY/CTN	PICTURED
251006599	W6005	6"	#5	30	1
251004596	W4005	4"	#5	100	2
251003602	W3004	3"	#4	200	3
251002595	W2505	2 1/2"	#5 - #6	245	4
251003585	W13MN	3"	#6 - #9	115	5
251002600	W97MN	2"	#4 - #6	300	6
251002579	W88MN	2"	M - #3	375	7
271001617	RMX2	1 7/8"	Mesh	425	8
251001594	W1534	1 1/2"	#5 - #6	625	9
271001624	R345 X 1 1/2	1 1/2"	#3 - #6	500	10
271001623	R345 X 1 1/4	1 1/4"	#3 - #6	575	11
251001577	W84MN	1 1/2"	M - #3	750	12
251001574	W14MN	1"	M - #5	1,000	13
271001607	R3X1	1"	#3	1,400	14
271001609	R4X1	1"	#4	1,250	15
271001611	R5X1	1"	#5	1,350	16

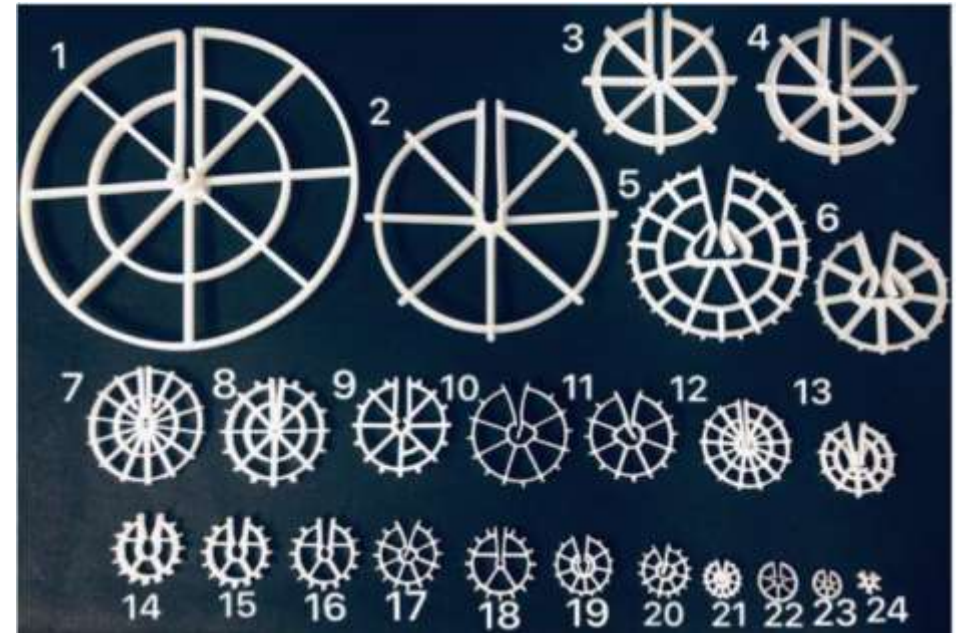

Made in America  U.S. Veteran Owned

Rebar/Mesh Supports • Spacer Wheels • Clips • Forming Accessories • Transportation Accessories • Tilt-Up Accessories

DCA CONSTRUCTION PRODUCTS

10421 Industrial Dr., Garrettsville, OH 44231 • 888-833-8308 • www.dcaproducts.com



## Preco<sup>®</sup> Wheel Assortment Cont'd

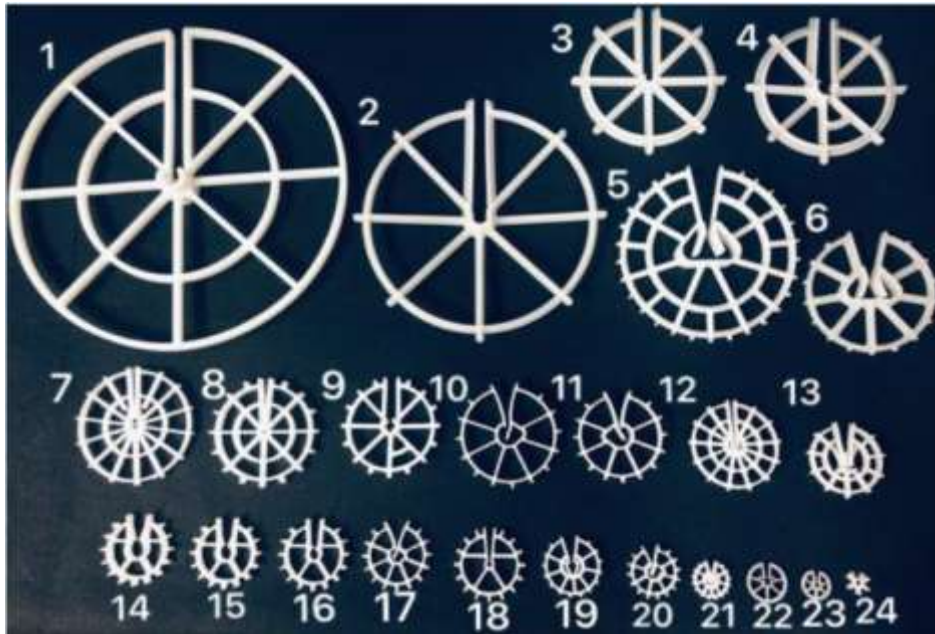

ITEM #	PRODUCT CODE	COVER	BAR SIZE	QTY/CTN	PICTURED
271001621	RM4X1	1"	#3	1,600	17
271001605	R1X1	1"	Mesh	1,300	18
251001593	W393MN	3/4"	#2 - #4	2,200	19
271001613	R1X3/4	3/4"	Mesh	4,000	20
251001589	W0512	1/2"	#1 - #2	5,500	21
271003627	R15/3-5	1/2"	#2	10,800	22
271003629	R10/3-5	3/8"	Mesh	23,000	23
211001546	STAR SPACER	9/16"	Mesh	26,000	24
251003586	W30MN	3"	M - #6	100	Not Pictured
251003583	W12MN	3"	M - #5	130	Not Pictured
251003587	<b>NEW!</b> W0348	3"	#4 - #8	95	Not Pictured
251003588	<b>NEW!</b> W0236	2"	#3 - #6	275	Not Pictured
08175279	W1023	1"	#2 - #3	1,800	Not Pictured
251001591	W13004	1"	#4	1,000	Not Pictured
271001615	R#10X1	1"	10 AWG Mesh	2,000	Not Pictured
271001619	RM4 x 5/8	5/8"	#3	3,100	Not Pictured

Made in America  U.S. Veteran Owned

Rebar/Mesh Supports • Spacer Wheels • Clips • Forming Accessories • Transportation Accessories • Tilt-Up Accessories

DCA CONSTRUCTION PRODUCTS

10421 Industrial Dr., Garrettsville, OH 44231 • 888-833-8308 • www.dcaproducts.com



# Preco<sup>®</sup> Rebar Chair (EAR)

**Application:**

- Precast, Cast-In-Place, or Tilt-Up
- Slab on Deck
- Slabs, Walls, and Above Grade

**Features:**

- Heavy Duty Design
- Accepts All Bar Sizes
- Fine Point Feet are Virtually Invisible

\* Meets requirements and qualifies as a CRSI Class 1 Bar Support

ITEM #	PRODUCT CODE	DESCRIPTION	COVER	QTY/CTN
131001441	EAR10	1" Rebar Chair	1"	2,000
131001443	EAR125	1 1/4" Rebar Chair	1-1/4"	1,750
131001445	EAR15	1 1/2" Rebar Chair	1-1/2"	1,425
131001447	EAR175	1 3/4" Rebar Chair	1-3/4"	1,200
131002449	EAR20	2" Rebar Chair	2"	550
131002450	EAR25	2 1/2" Rebar Chair	2-3/2"	500
131003452	EAR30	3" Rebar Chair	3"	250
131003454	EAR35	3 1/2" Rebar Chair	3-1/2"	250
131004457	EAR40	4" Rebar Chair	4"	200



Made in America  U.S. Veteran Owned

Rebar/Mesh Supports • Spacer Wheels • Clips • Forming Accessories • Transportation Accessories • Tilt-Up Accessories

DCA CONSTRUCTION PRODUCTS

10421 Industrial Dr., Garrettsville, OH 44231 • 888-833-8308 • www.dcaproducts.com



# Preco<sup>®</sup> Mesh Chair (EAM)

**Application:**

- Precast, Cast-In-Place, or Tilt-Up
- Slab on Deck
- Slabs, Walls, and Above Grade

**Features:**

- Heavy Duty Design
- Fine Point Feet are Virtually Invisible

*\* Meets requirements and qualifies as a CRSI Class 1 Bar Support*

ITEM #	PRODUCT CODE	DESCRIPTION	COVER	QTY/CTN
141001461	EAM75	3/4" Mesh Chair	3/4"	4,350
141001463	EAM10	1" Mesh Chair	1"	2,000
141001465	EAM15	1 1/2" Mesh Chair	1-1/2"	1,600
141002469	EAM20	2" Mesh Chair	2"	575
141002470	EAM25	2 1/2" Mesh Chair	2-1/2"	500
141003474	EAM30	3" Mesh Chair	3"	250

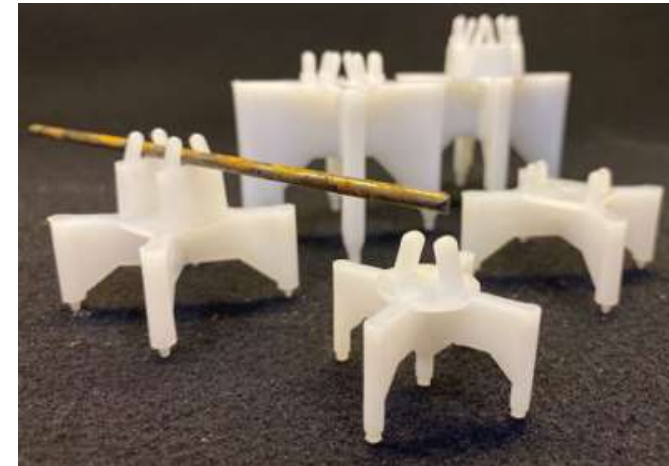

Made in America  U.S. Veteran Owned

Rebar/Mesh Supports • Spacer Wheels • Clips • Forming Accessories • Transportation Accessories • Tilt-Up Accessories

DCA CONSTRUCTION PRODUCTS

10421 Industrial Dr., Garrettsville, OH 44231 • 888-833-8308 • www.dcaproducts.com



# Preco<sup>®</sup> High Stack Chair (HIC)

## Application:

- Precast, Cast-In-Place, Tilt-Up
  - Slab on deck, or slab on grade w/base plate
- \* Meets requirements and qualifies as a CRSI Class 1 Bar Support*

## Features:

- Heavy duty design – high-density polyethylene
- Stackable system for a variety of coverages
- Small-point architectural feet or flat feet available

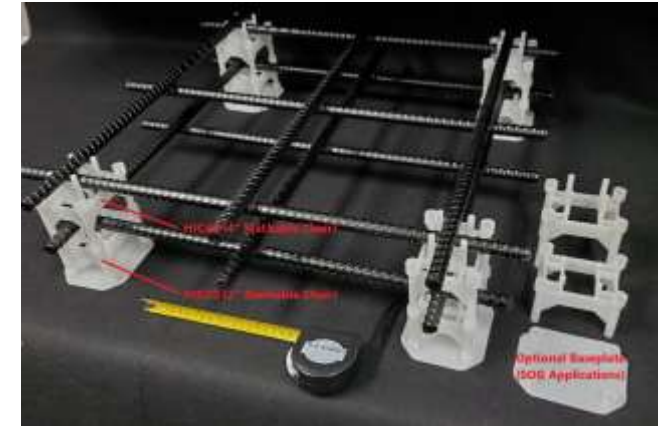

ITEM #	PRODUCT CODE	DESCRIPTION	COVER	QTY/CTN
121001410	HIC15	Stackable Chair	1-1/2"	225
121002415	HIC20	Stackable Chair	2"	270
121002418	HIC25	Stackable Chair	2-1/2"	250
121003423	HIC30	Stackable Chair	3"	190
121003427	HIC35	Stackable Chair	3-1/2"	180
121004431	HIC40	Stackable Chair	4"	180
121000435	Base Plate	Base Plate	N/A	400

ITEM #	PRODUCT CODE	DESCRIPTION	COVER	QTY/CTN
121001412	HIC15A	High Stack Arc Chair	1-1/2"	225
121002417	HIC20A	High Stack Arc Chair	2"	270
12100242	HIC25A	High Stack Arc Chair	2-1/2"	250
121003425	HIC30A	High Stack Arc Chair	3"	190
121003429	HIC35A	High Stack Arc Chair	3-1/2"	180
121004433	HIC40A	High Stack Arc Chair	4"	180

Made in America  U.S. Veteran Owned

Rebar/Mesh Supports • Spacer Wheels • Clips • Forming Accessories • Transportation Accessories • Tilt-Up Accessories

DCA CONSTRUCTION PRODUCTS

10421 Industrial Dr., Garrettsville, OH 44231 • 888-833-8308 • www.dcaproducts.com



## Preco<sup>®</sup> Crown Chair – *NEW!*

### Application:

- Cast-In-Place
- Slab-on-Grade
- Precast
- Tilt-Up
- Insulated sandwich panels

### Features:

- Exclusive dual design for rebar (up to #8) and mesh ( 6 AWG - 10 AWG).
- Cover height from 1 1/2" to 4" (1/2" increments).
- Unique clip design for efficient installation with mesh. (Easy clip / hang technology.)
- Large round base for stability.
- Made in U.S.A.

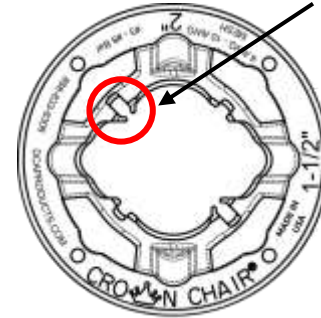

ITEM #	PRODUCT CODE	DESCRIPTION	BAR SIZE	QTY/CTN
231002501	CRWN20	1 1/2" - 2" Crown Chair XD	up to #8 bar, 6 AWG - 10 AWG mesh	792
231002502	CRWN30	2 1/2" - 3" Crown Chair XD	up to #8 bar, 6 AWG - 10 AWG mesh	387
231002503	CRWN40	3 1/2" - 4" Crown Chair XD	up to #8 bar, 6 AWG - 10 AWG mesh	217

Made in America  U.S. Veteran Owned

Rebar/Mesh Supports • Spacer Wheels • Clips • Forming Accessories • Transportation Accessories • Tilt-Up Accessories

DCA CONSTRUCTION PRODUCTS

10421 Industrial Dr., Garrettsville, OH 44231 • 888-833-8308 • [www.dcaproducts.com](http://www.dcaproducts.com)



## Preco<sup>®</sup> Paving Chair – *NEW!*

### Application:

- DOT paving
- Slab-on-Grade
- Single Mat

### Features:

- Round base for stable rebar support.
- Snap-in clips allow bar to securely remain in place.
- Easy install saves time and money.
- Available without a base for smaller footprint.

ITEM #	DESCRIPTION	BAR SIZE	QTY/CTN
131001465	1 1/2" Paving Chair w/ Base	#3-#8	750
131002466	2" Paving Chair w/ Base	#3-#6	650
131002467	2 1/4" Paving Chair w/ Base	#3-#6	650
131002459	2 1/2" Paving Chair w/ Base	#3-#6	600
131003468	3" Paving Chair w/ Base	#3-#6	550
131003461	3 1/4" Paving Chair w/ Base	#3-#6	500
131003469	3 1/2" Paving Chair w/ Base	#3-#6	500
131004479	4" Paving Chair w/ Base	#2-#5	425



Made in America  U.S. Veteran Owned

Rebar/Mesh Supports • Spacer Wheels • Clips • Forming Accessories • Transportation Accessories • Tilt-Up Accessories

DCA CONSTRUCTION PRODUCTS

10421 Industrial Dr., Garrettsville, OH 44231 • 888-833-8308 • www.dcaproducts.com



## Preco<sup>®</sup> HD Rebar Chair – NEW!

### Application:

- Slab-on-Grade

### Features:

- Square base for extra support for heavier loads.
- Snap-in clips allow bar to securely remain in place.

ITEM #	PRODUCT CODE	DESCRIPTION	BAR SIZE	QTY/CTN
131004458	HDRC40	4" Heavy Duty Rebar Chair	#3 - #6	125
131004459	HDRC45	4 1/2" Heavy Duty Rebar Chair	#3 - #6	115
131004460	HDRC50	5" Heavy Duty Rebar Chair	#3 - #6	100
131004461	HDRC55	5 1/2" Heavy Duty Rebar Chair	#3 - #6	100



Made in America  U.S. Veteran Owned

Rebar/Mesh Supports • Spacer Wheels • Clips • Forming Accessories • Transportation Accessories • Tilt-Up Accessories

DCA CONSTRUCTION PRODUCTS

10421 Industrial Dr., Garrettsville, OH 44231 • 888-833-8308 • [www.dcaproducts.com](http://www.dcaproducts.com)



## Preco<sup>®</sup> Precast Rebar Chair

### Application:

- Precast
- At grade

### Features:

- Made of virgin HDPE resin only.
- No base for smaller footprint
- Snap-in clips allow bar to securely remain in place.
- Natural color for minimal bleed

ITEM #	DESCRIPTION	BAR SIZE	QTY/CTN
	1 1/2" Chair	#3-#8	1,300
131002480	2" Chair	#3-#6	1,275
	2 1/2" Chair	#3-#6	TBD
	3" Chair	#3-#6	TBD
	3 1/2" Chair	#3-#6	TBD
131004490	4" Chair	#2-#5	700



Made in America  U.S. Veteran Owned

Rebar/Mesh Supports • Spacer Wheels • Clips • Forming Accessories • Transportation Accessories • Tilt-Up Accessories

DCA CONSTRUCTION PRODUCTS

10421 Industrial Dr., Garrettsville, OH 44231 • 888-833-8308 • [www.dcaproducts.com](http://www.dcaproducts.com)



# Preco<sup>®</sup> Barspan Clip

**Application:**

- Precast
- Slab-on-Deck
- Slab-on-Grade
- Walls & Above Grade

**Features:**

- Easily supports extra load
- Wide range general purpose clip

*\* Meets requirements and qualifies as a CRSI Class 1 Bar Support*

ITEM #	PRODUCT CODE	BAR SIZE	COVER	QTY/CTN
281001631	C16SN	Mesh-#5	1"	3,100
281002635	C20SN	Mesh-#7	1 1/2"	1,750
281002637	C22SN	Mesh-#9	2"	1,100
281002639	C21SN	Mesh-#9	2 1/2"	675
281001633	C34MX	#2-#8	1 1/2"	800



Made in America  U.S. Veteran Owned

Rebar/Mesh Supports • Spacer Wheels • Clips • Forming Accessories • Transportation Accessories • Tilt-Up Accessories

DCA CONSTRUCTION PRODUCTS

10421 Industrial Dr., Garrettsville, OH 44231 • 888-833-8308 • [www.dcaproducts.com](http://www.dcaproducts.com)



# Preco<sup>®</sup> Rebar Clip

### Application:

- Precast, Cast-In-Place
- Slab-on-Deck & Slab-on-Grade
- Walls & Above Grade

### Features:

- Easily supports extra load
- Wide Range General Purpose Clip

\* Meets requirements and qualifies as a CRSI Class 1 Bar Support

ITEM #	PRODUCT CODE	DESCRIPTION	BAR SIZE	QTY/CTN
291001651	CH345 X 1	1" Cover Clip	#3 - #5	2,600
291001653	CH345 X 1 1/2	1 1/2" Cover Clip	#3 - #5	1,800
291002656	CH345 X 2	2" Cover Clip	#3 - #5	950
291002655	CH345 X 2 1/2	2 1/2" Cover Clip	#3 - #5	500
301501681	C-CLIP	1/2" Cover Clip	#3 - #7	7,800
301501682	F-CLIP	3/4" Cover Clip	#3 - #6	4,500
301501684	G-CLIP	1" Cover Clip	#2 & #3	4,500
301301687	H-CLIP	1" Cover Clip	#4 - #6	3,500
301501689	J-CLIP	1 1/2" Cover Clip	#2 & #3	2,950
301501691	K-CLIP	1 1/2" Cover Clip	#4 - #6	2,200
301502693	M-CLIP	2" Cover Clip	#4 - #6	1,500



Made in America  U.S. Veteran Owned

Rebar/Mesh Supports • Spacer Wheels • Clips • Forming Accessories • Transportation Accessories • Tilt-Up Accessories

DCA CONSTRUCTION PRODUCTS

10421 Industrial Dr., Garrettsville, OH 44231 • 888-833-8308 • www.dcaproducts.com



## Preco<sup>®</sup> Slab Bolsters

### Application:

- Slab on Grade with a Plate
- Slab on Deck
- Precast
- Walls & Above Grade

### Features:

- Extra heavy duty - holds over 640lbs. per 1/4 sq. in.
- Small feet make this slab bolster undetected in formwork.
- Can be locked together for desired length.
- Non-corrosive, extremely durable
- Up to 360° bend without breakage.

ITEM #	PRODUCT CODE	DESCRIPTION	QTY./CTN.
112401384	SB075XHD	3/4" x 2 1/2' Slab Bolster, 80pcs.	200 LF
112401386	SB100XHD	1" x 2 1/2' Slab Bolster, 80pcs.	200 LF
112401388	SB125XHD	1 1/4" x 2 1/2' Slab Bolster, 70pcs.	175 LF
112401390	SB150XHD	1 1/2" x 2 1/2' Slab Bolster, 55pcs.	137.5 LF
112401392	SB175XHD	1 3/4" x 2 1/2' Slab Bolster, 40pcs.	100 LF
112402394	SB200XHD	2" x 2 1/2' Slab Bolster, 40pcs.	100 LF
112402396	SB225XHD	2 1/4" x 2 1/2' Slab Bolster, 40pcs.	100 LF
112402400	SB250XHD	2 1/2" x 2 1/2' Slab Bolster, 40pcs.	100 LF
112402402	SB275XHD	2 3/4" x 2 1/2' Slab Bolster, 32pcs.	80 LF
112403404	SB300XHD	3" x 2 1/2' Slab Bolster, 32pcs.	80 LF

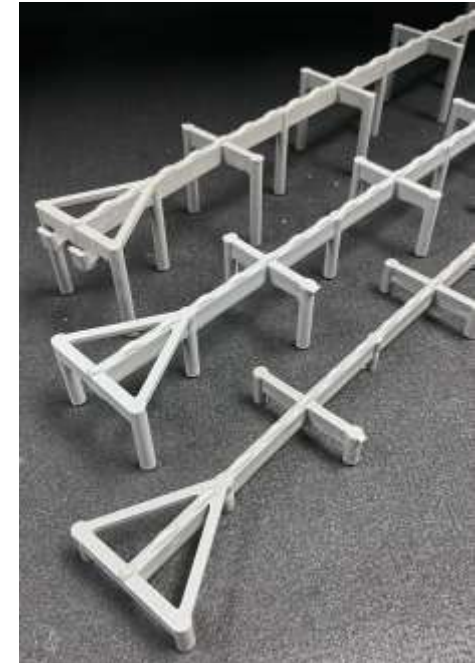

Made in America  U.S. Veteran Owned

Rebar/Mesh Supports • Spacer Wheels • Clips • Forming Accessories • Transportation Accessories • Tilt-Up Accessories

DCA CONSTRUCTION PRODUCTS

10421 Industrial Dr., Garrettsville, OH 44231 • 888-833-8308 • www.dcaproducts.com



## Preco<sup>®</sup> Board Cap (Void Cap)

### Application:

- Creates a clean, professional groove over expansion board.
- Lower section of this polystyrene cap is placed over the top of the expansion board before the placement of concrete
- Top section is removed to create a smooth “notched” reservoir for sealant.

### Features:

- Unique single Anchor J-Hook Design
- Grip-Rite allows the cap to “snap” into place on the expansion board

ITEM #	PRODUCT CODE	DESCRIPTION	SIZE	QTY./CTN.
101210361	BC375	3/8" Board Cap w/ Anchor Hook	3/8" X 10'	800LF
101210362	BC500	1/2" Board Cap w/ Anchor Hook	1/2" X 10'	500LF
101210375	BC750	3/4" Board Cap w/ Anchor Hook	3/4" X 10'	400LF
101210377	BC1000	1" Board Cap w/ Anchor Hook	1" X 10'	250LF

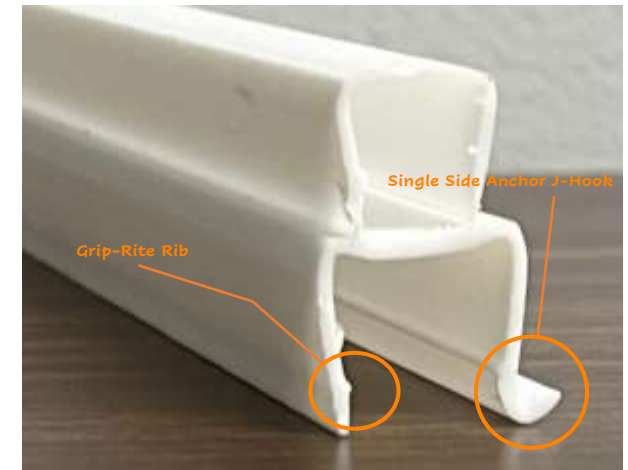
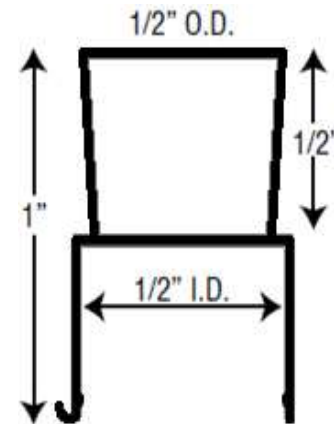

Made in America  U.S. Veteran Owned

Rebar/Mesh Supports • Spacer Wheels • Clips • Forming Accessories • Transportation Accessories • Tilt-Up Accessories

DCA CONSTRUCTION PRODUCTS

10421 Industrial Dr., Garrettsville, OH 44231 • 888-833-8308 • www.dcaproducts.com



## Preco<sup>®</sup> T-Strip

### Application:

- Eliminates random cracking in all variations of on-grade slabs
- Creates a straight line surface joint.
- When inserted into wet concrete it offers the advantage of a radius edge tooling the joint in sidewalks, driveways, patio decks, and other various walkways

### Features:

- Economic alternative to saw cutting
- Leaves no telegraphed lines in Tilt-Up panel walls after they are raised

ITEM #	PRODUCT CODE	DESCRIPTION	QTY/CTN
101210379	TS110	1" x 10' T-Strip, 50 pcs.	500 LF
101210378	TS210	1-1/2" x 10' T-Strip, 50 pcs.	500 LF
101210380	TS310	2" x 10' T-Strip, 50 pcs.	500 LF

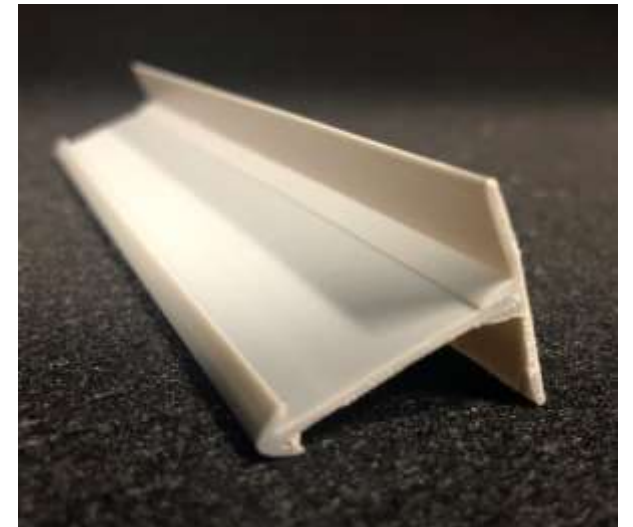

Made in America  U.S. Veteran Owned

Rebar/Mesh Supports • Spacer Wheels • Clips • Forming Accessories • Transportation Accessories • Tilt-Up Accessories

DCA CONSTRUCTION PRODUCTS

10421 Industrial Dr., Garrettsville, OH 44231 • 888-833-8308 • [www.dcaproducts.com](http://www.dcaproducts.com)



# Preco<sup>®</sup> Rigid Dual Chamfer

**Application:**

- Tilt-Up Panel Construction

**Features:**

- Lays Flat
- Less Adhesive Needed
- Heavy Duty Rigid Design

ITEM #	PRODUCT CODE	DESCRIPTION	COVER	QTY/CTN
490801778	DUAL CHAMFER	2 3/4" x 10' Rigid Dual Chamfer	3/4"	120 LF

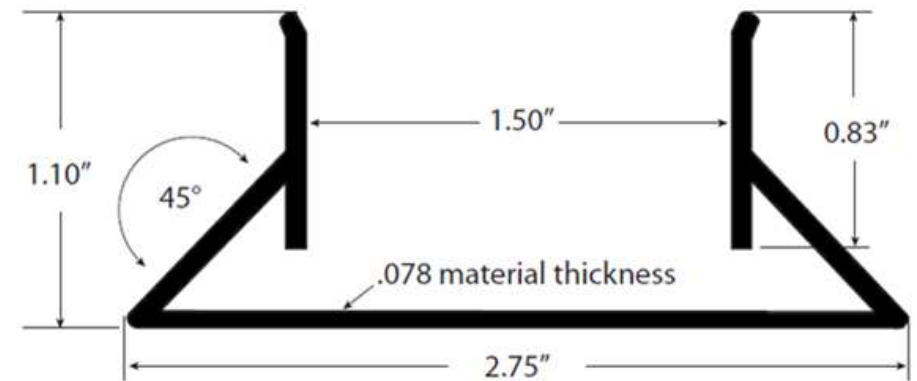

Made in America  U.S. Veteran Owned

Rebar/Mesh Supports • Spacer Wheels • Clips • Forming Accessories • Transportation Accessories • Tilt-Up Accessories

DCA CONSTRUCTION PRODUCTS

10421 Industrial Dr., Garrettsville, OH 44231 • 888-833-8308 • www.dcaproducts.com



# Preco<sup>®</sup> Chamfer Assortment

**Application:**

- Forming edges in concrete.

**Features:**

- Available with or without radius and nailing flange.
- Available in rolls or 8' and 10' sections
- Flexible and easy-to-use
- Reusable for multiple pours



ITEM #	PRODUCT CODE	DESCRIPTION	COVER	QTY/CTN
340801794	RF050	1/2" x 500' Radius Chamfer w/ Nailing Flange	1/2" x 1/2"	1
340801796	RF075	5/8" x 300' Radius Chamfer w/ Nailing Flange	3/4" x 5/8"	1
340801798	RF100	7/8" x 180' Radius Chamfer w/ Nailing Flange	1" x 7/8"	1
340801780	CHN50	1/2" x 250' Chamfer w/ Flange	1/2" x 1/2"	1
340801782	CHN75	3/4" x 33250' Chamfer w/ Flange	3/4" x 3/4"	1
340801784	CHN10	1" x 150' Chamfer w/ Flange	1" x 1"	1
340801786	VP663	3/4" x 100' Double Chamfer	1/2" x 3/4"	4

ITEM #	PRODUCT CODE	DESCRIPTION	COVER	QTY/CTN
340801770	CH050	1/2" x 100' Chamfer	1/2" x 1/2"	5
340801772	CH075	3/4" x 350' Chamfer	3/4" x 3/4"	1
340801774	CH100	1" x 170' Chamfer	1" x 1"	1
340802776	CH200	2" x 10' Chamfer	2" x 2"	8

Made in America  U.S. Veteran Owned

Rebar/Mesh Supports • Spacer Wheels • Clips • Forming Accessories • Transportation Accessories • Tilt-Up Accessories

DCA CONSTRUCTION PRODUCTS

10421 Industrial Dr., Garrettsville, OH 44231 • 888-833-8308 • www.dcaproducts.com



## Preco<sup>®</sup> Reveal Strip

**Application:**

- Tilt-up, Cast-in-Place, and Precast

**Features:**

- Smooth finish for easy release
- Reusable



ITEM #	PRODUCT CODE	DESCRIPTION	QTY./CTN.
491210809	REVEALSTRIP	3/4" x 2 1/4" x 10' Reveal Strip	770 LF

Made in America  U.S. Veteran Owned

Rebar/Mesh Supports • Spacer Wheels • Clips • Forming Accessories • Transportation Accessories • Tilt-Up Accessories

DCA CONSTRUCTION PRODUCTS

10421 Industrial Dr., Garrettsville, OH 44231 • 888-833-8308 • [www.dcaproducts.com](http://www.dcaproducts.com)



# Preco® Rocket Dowel – *NEW!*

**Application:**

Your go-to slip dowel installation system for slab-on-grade construction joints.

- Stamped Concrete
- Distribution Centers
- Warehouses
- Parking Facilities & much more!

**Features:**

- Proudly made in the USA!
- Ease of Use - Exclusive color-coding w/ sleeves & bases!
- Time Saving – No pre-drilling necessary!
- Use with smooth or deformed dowels
- Allows dowel movement within the sleeve.
- Reusable bases



**Dowel Sleeves**

ITEM #	PRODUCT CODE	DESCRIPTION	SIZE	COLOR	QTY/CTN
352009058	4RDS9	5/8" Smooth or #4 Rebar Sleeve, 25 Pc. / Bag - 24 Bags	9"	Black	600
352009034	5RDS9	3/4" Smooth or #5 Rebar Sleeve, 25 Pc. / Bag - 18 Bags	9"	Gray	450
352009078	6RDS9	7/8" Smooth or #6 Rebar Sleeve, 25 Pc. / Bag - 14 Bags	9"	White	350
352012058	4RDS12	5/8" Smooth or #4 Rebar Sleeve, 25 Pc. / Bag - 18 Bags	12"	Black	450
352012034	5RDS12	3/4" Smooth or #5 Rebar Sleeve, 25 Pc. / Bag - 14 Bags	12"	Gray	350
352012078	6RDS12	3/4" Smooth or #6 Rebar Sleeve, 25 Pc. / Bag – 11 Bags	12"	White	275

ITEM #	PRODUCT CODE	DESCRIPTION	COLOR	QTY/CTN
352001258	4RDB	5/8" Smooth or #4 Rebar Sleeve Base, 25pc / Bag – 38 Bags	Black	950
352001234	5RDB	3/4" Smooth or #5 Rebar Sleeve Base, 25pc / Bag – 34 Bags	Gray	850
352001278	6RDB	7/8" Smooth or #6 Rebar Sleeve Base, 25pc / Bag – 32 Bags	White	800

Made in America  U.S. Veteran Owned

Rebar/Mesh Supports • Spacer Wheels • Clips • Forming Accessories • Transportation Accessories • Tilt-Up Accessories

DCA CONSTRUCTION PRODUCTS

10421 Industrial Dr., Garrettsville, OH 44231 • 888-833-8308 • www.dcaproducts.com



## Preco<sup>®</sup> Slab Protector

### Application:

- Tilt-Up
- Safe, effective, easy way of protecting floors from damage when walls are lifted.

### Features:

- Eliminates the need for costly floor repairs
- Impact resistant



ITEM #	PRODUCT CODE	DESCRIPTION	QTY/CTN
350402802	PROTECTOR	2' Slab Protector	32

Made in America  U.S. Veteran Owned

Rebar/Mesh Supports • Spacer Wheels • Clips • Forming Accessories • Transportation Accessories • Tilt-Up Accessories

DCA CONSTRUCTION PRODUCTS

10421 Industrial Dr., Garrettsville, OH 44231 • 888-833-8308 • [www.dcaproducts.com](http://www.dcaproducts.com)



## Preco<sup>®</sup> Keyway

### Application:

- Light, flexible and easy way to mold a keyed tongue and groove construction joint in tilt-up buildings, industrial floors, curbs, driveways or wherever specified.

### Features:

- Impact resistant
- Won't split, chip, or crack at any temperature
- Simple design
- Strips quickly for reuse or leave in place



ITEM #	PRODUCT CODE	DESCRIPTION	QTY/CTN
100310386	KEYWAY3.5	3.5" x 10' Plastic Nail-On Keyway	16

Made in America  U.S. Veteran Owned

Rebar/Mesh Supports • Spacer Wheels • Clips • Forming Accessories • Transportation Accessories • Tilt-Up Accessories

DCA CONSTRUCTION PRODUCTS

10421 Industrial Dr., Garrettsville, OH 44231 • 888-833-8308 • [www.dcaproducts.com](http://www.dcaproducts.com)



## Preco<sup>®</sup> Poly Wind Clip

### Application:

- Easily clips onto scaffolding to secure poly sheeting.

### Features:

- Standard 11" length
- Reusable
- Inexpensive
- Saves time and material

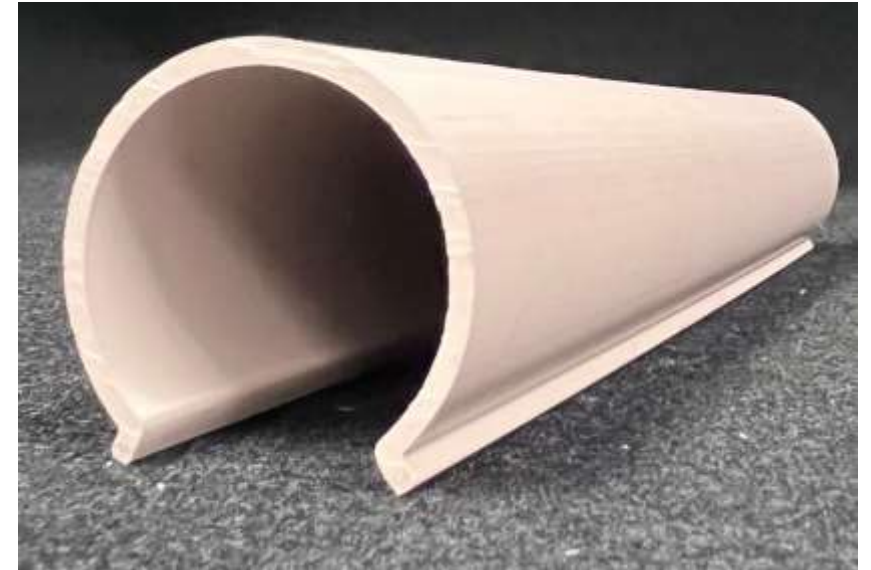

ITEM #	PRODUCT CODE	DESCRIPTION	QTY./CTN.
301511696	WINDCLP	11" Poly Wind Clip	190

Made in America  U.S. Veteran Owned

Rebar/Mesh Supports • Spacer Wheels • Clips • Forming Accessories • Transportation Accessories • Tilt-Up Accessories

DCA CONSTRUCTION PRODUCTS

10421 Industrial Dr., Garrettsville, OH 44231 • 888-833-8308 • [www.dcaproducts.com](http://www.dcaproducts.com)



## Preco<sup>®</sup> De-Bonding Sheathing

### Application:

- Precast, Prestressed

### Features:

- Flexible plastic sheathing designed to create a de-bonded area on a prestressed strand.
- Easy to use.
- Economical and saves time.
- Available in high visibility Preco<sup>®</sup> Orange.

ITEM #	PRODUCT CODE	DESCRIPTION	QTY/CTN	LF/CTN
431405904	PRS30	.50" x 5' Slit Sheathing	500	2,500
431405906	PRS30	.50" x 5' Slit Sheathing – Orange	500	2,500
431410908	PRS30-10	.50" x 10' Slit Sheathing	250	2,500
431410910	PRS30-10	.50" x 10' Slit Sheathing – Orange	250	2,500
431410914	NSS15	.60" x 10' Non-Slit Sheathing	150	1,500
431410912	NSS20	.67" x 10' Non-Slit Sheathing	175	1,500



Made in America  U.S. Veteran Owned

Rebar/Mesh Supports • Spacer Wheels • Clips • Forming Accessories • Transportation Accessories • Tilt-Up Accessories

DCA CONSTRUCTION PRODUCTS

10421 Industrial Dr., Garrettsville, OH 44231 • 888-833-8308 • [www.dcaproducts.com](http://www.dcaproducts.com)



## Preco<sup>®</sup> Recess Plug

**Application:**

- Precast
- Used to form a void around strand to create a pocket so the strand can be recessed in the concrete.



ITEM #	PRODUCT CODE	DESCRIPTION	QTY/CTN
359901810	RECESS PLUG	1 1/8" x 1 1/8" x 3/4" Recess Plug	6000

*Made in America*  *U.S. Veteran Owned*

Rebar/Mesh Supports • Spacer Wheels • Clips • Forming Accessories • Transportation Accessories • Tilt-Up Accessories

DCA CONSTRUCTION PRODUCTS

10421 Industrial Dr., Garrettsville, OH 44231 • 888-833-8308 • [www.dcaproducts.com](http://www.dcaproducts.com)



# Preco<sup>®</sup> Graphite Spray

**Application:**

- Dry-film lubricant, ideal for on-the-job application.
- Designed to lubricate strand chucks for re-use.
- Prestressed Concrete

**Features:**

- Easy-to-use Aerosol spray

ITEM #	PRODUCT CODE	DESCRIPTION	QTY/CTN
439912916	GRAPHITE	12 oz. Graphite Spray	24



Made in America  U.S. Veteran Owned

Rebar/Mesh Supports • Spacer Wheels • Clips • Forming Accessories • Transportation Accessories • Tilt-Up Accessories

DCA CONSTRUCTION PRODUCTS

10421 Industrial Dr., Garrettsville, OH 44231 • 888-833-8308 • [www.dcaproducts.com](http://www.dcaproducts.com)



## Preco<sup>®</sup> Form Clean

### Application:

- Excellent for cleaning the surface of wood, steel, and fiberglass forms
- Proprietary blend of solvents designed to quickly cut oils, dirt, and dust to clean surfaces.

### Features:

- Excellent preparation prior to applying sealants (hybrid adhesives/silicone caulk) to forms
- Allows for easy attachment of inserts

ITEM #	PRODUCT CODE	DESCRIPTION	QTY/CTN
429912900	FORMCLN	12 oz. Form Clean	24



Made in America  U.S. Veteran Owned

Rebar/Mesh Supports • Spacer Wheels • Clips • Forming Accessories • Transportation Accessories • Tilt-Up Accessories

DCA CONSTRUCTION PRODUCTS

10421 Industrial Dr., Garrettsville, OH 44231 • 888-833-8308 • [www.dcaproducts.com](http://www.dcaproducts.com)



## Preco<sup>®</sup> SET-FAST Silicone Sealant

### Application:

- Premium, general purpose, single-component, room temperature vulcanizing RTV acetoxy cure silicone sealant and adhesive.
- Precast concrete, transportation seals, industrial gaskets, sanitary seals, HVAC/R, roofing, plumbing, kitchen and bath, countertops, appliance trim, marine cabins, etc.

### Features:

- Forms waterproof and airtight bonds to metal, steel, tile, fiberglass, ceramic, glass, aluminum, painted surfaces, plywood, marbles, and many more common substrates.
- Permanent Flexibility
- VOC Compliant
- Interior and Exterior Applications

ITEM #	PRODUCT CODE	DESCRIPTION	QTY/CTN
369910814	SET-FAST WHITE	Silicone Sealant 10.3 oz. Tube - WHITE	24
369910816	SET-FAST CLEAR	Silicone Sealant 10.3 oz. Tube – CLEAR	24



Made in America  U.S. Veteran Owned

Rebar/Mesh Supports • Spacer Wheels • Clips • Forming Accessories • Transportation Accessories • Tilt-Up Accessories

DCA CONSTRUCTION PRODUCTS

10421 Industrial Dr., Garrettsville, OH 44231 • 888-833-8308 • [www.dcaproducts.com](http://www.dcaproducts.com)



# Preco<sup>®</sup> Neutral Cure Sealant - 100% Silicone

### Application:

- One-component, non-sag, permanently flexible neutral cure silicone sealant.
- Engineered to deliver excellent adhesion to common building materials without the need of a primer.
- Precast concrete structures, transportation seals, industrial gaskets

### Features:

- Cures rapidly when exposed to atmospheric moisture to form a durable bond.
- 100% Silicone – acetoxy free
- Permanent flexibility
- Temperature range -40°F to 350°F
- Use for interior and exterior applications.

ITEM #	DESCRIPTION	QTY/CTN
369910817	100% Silicone Sealant 10.3 oz. Tube - CLEAR	24
369910818	100% Silicone Sealant 10.3 oz. Tube – WHITE	24



Made in America  U.S. Veteran Owned

Rebar/Mesh Supports • Spacer Wheels • Clips • Forming Accessories • Transportation Accessories • Tilt-Up Accessories

DCA CONSTRUCTION PRODUCTS

10421 Industrial Dr., Garrettsville, OH 44231 • 888-833-8308 • www.dcaproducts.com



# Preco<sup>®</sup> Single Component Sealant / Adhesive Guns

**Application:**

- For use with Preco<sup>®</sup> Set-Fast Silicone sealants and construction sealant / adhesive tubes.

**Features:**

- Drip/Dripless<sup>®</sup> Switch
- Pressure Release Switch (ETS 9000)
- Lifetime Replacement Warranty
- For Thicker Sealants/Adhesives

ITEM #	PRODUCT CODE	DESCRIPTION	QTY/CTN
369900901	ETS 3000 PRO	Single Component Silicone Sealant Gun, 18:1 Thrust Ratio	1
369910816	ETS 9000 BEAST	Single Component Silicone Sealant Gun, 26:1 Thrust Ratio	1



ETS 3000 PRO



ETS 9000 BEAST

Made in America  U.S. Veteran Owned

Rebar/Mesh Supports • Spacer Wheels • Clips • Forming Accessories • Transportation Accessories • Tilt-Up Accessories

DCA CONSTRUCTION PRODUCTS

10421 Industrial Dr., Garrettsville, OH 44231 • 888-833-8308 • www.dcaproducts.com



# Preco<sup>®</sup> Coil Loop Insert Protectors and Removal Tool

**Applications:**

- Precast
- Cast-In-Place
- Tilt-Up

**Features:**

- Protects the helix of a coil loop insert during the pour
- Heavy-duty design

ITEM #	PRODUCT CODE	DESCRIPTION	SIZE	QTY/CTN
401001856	INS50	Coil Loop Insert Protector – Small	1/2"	1,625
401001851	INS75	Coil Loop Insert Protector – Medium	3/4"	425
401001855	INS10	Coil Loop Insert Protector – Large	1"	215
409900856	REM10	Removal Tool (Medium/Large)	Fits 3/4" – 1" Insert	1

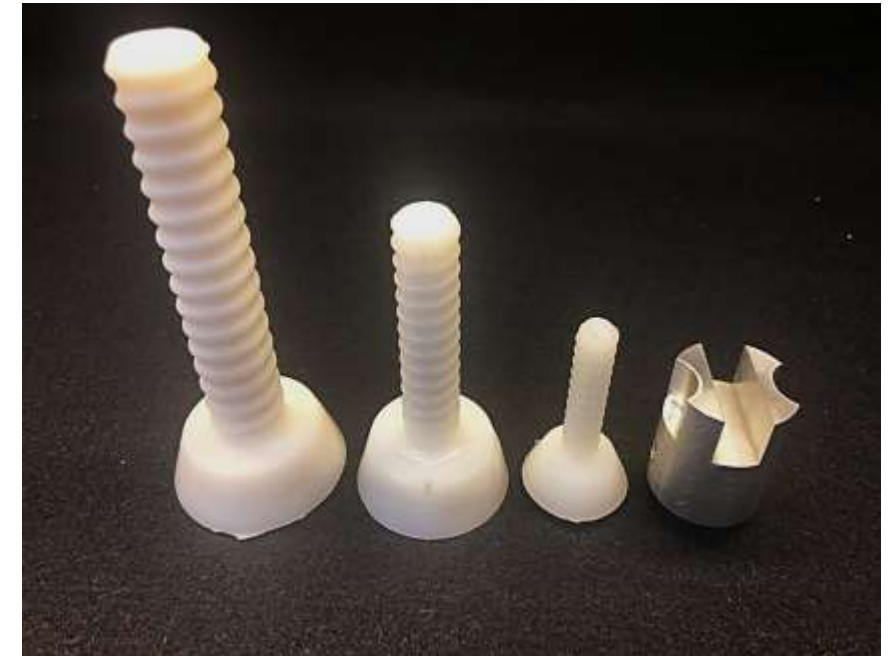

Made in America  U.S. Veteran Owned

Rebar/Mesh Supports • Spacer Wheels • Clips • Forming Accessories • Transportation Accessories • Tilt-Up Accessories

DCA CONSTRUCTION PRODUCTS

10421 Industrial Dr., Garrettsville, OH 44231 • 888-833-8308 • www.dcaproducts.com



## Preco<sup>®</sup> Panel Ties

### Applications:

- Designed to hold void formers and or sandwich panel foam insulation in place during the casting of concrete

### Features:

- Manufactured using natural, virgin material to avoid color contamination
- Will not stain concrete

ITEM #	PRODUCT CODE	DESCRIPTION	SIZE	QTY/CTN
391003845	TIESS	3 3/8" Panel Tie	3 3/8"	1,800
391004843	TIESD	4 1/4" Double Panel Tie	4 1/4"	3,000
391005847	TIESF	5 5/8" Panel Tie	5 5/8"	1,100
391007849	TIESP	7 7/8" Panel Tie	7 7/8"	720



Made in America  U.S. Veteran Owned

Rebar/Mesh Supports • Spacer Wheels • Clips • Forming Accessories • Transportation Accessories • Tilt-Up Accessories

DCA CONSTRUCTION PRODUCTS

10421 Industrial Dr., Garrettsville, OH 44231 • 888-833-8308 • [www.dcaproducts.com](http://www.dcaproducts.com)



## Preco<sup>®</sup> OSHA Rebar Safety Cap

**Application:**

- Covers tops of rebar

**Features:**

- Reusable Design
- Heavy Duty
- Labor saving EZ-Installation<sup>®</sup>

ITEM #	PRODUCT CODE	DESCRIPTION	QTY/CTN
449903929	SMCAP	OSHA Rebar Safety Cap #3 - #8 Bar	100
449903931	LGCAP	OSHA Rebar Safety Cap #3 - #11 Bar	25



Made in America  U.S. Veteran Owned

Rebar/Mesh Supports • Spacer Wheels • Clips • Forming Accessories • Transportation Accessories • Tilt-Up Accessories

DCA CONSTRUCTION PRODUCTS

10421 Industrial Dr., Garrettsville, OH 44231 • 888-833-8308 • [www.dcaproducts.com](http://www.dcaproducts.com)



*Made in America*  *U.S. Veteran Owned*

---

**Rebar/Mesh Supports • Spacer Wheels • Clips • Forming Accessories • Transportation Accessories • Tilt-Up Accessories**

---

**DCA CONSTRUCTION PRODUCTS**

10421 Industrial Dr., Garrettsville, OH 44231 • 888-833-8308 • [www.dcaproducts.com](http://www.dcaproducts.com)

